

## Standard Preparation 1300 mm Work Table

ITEM # \_\_\_\_\_

MODEL # \_\_\_\_\_

NAME # \_\_\_\_\_

SIS # \_\_\_\_\_

AIA # \_\_\_\_\_

**133220 (TG1300N)**

Work table 1300 mm

### Short Form Specification

**Item No.** \_\_\_\_\_

The 50mm high worktop in 304 AISI stainless steel, 1mm in thickness, has upturned edges and incorporates a layer of sound deadening, waterproof and fireproof material. Square section legs 40x40mm on 1" height-adjustable feet in 304 AISI stainless steel.

### Main Features

- Ideal for central positioning in the kitchen, either as island installation or back to back.

### Construction

- 50 mm worktop in 304 AISI stainless steel, 10/10 in thickness with upturned edges and reinforced waterproof underpanel, incorporates a layer of sound deadening materials.
- 400 or 600 mm wide single drawer, chest of 4 drawers, lower shelf, three-sided underframe and set of castors as alternative to the feet, can be fitted as optional on all work tables.
- 40 mm-thick lower shelf (available as optional accessory on some models) slots easily into place at a height of 200 mm from the floor. Lower shelf is compulsory to install the chest of drawers.
- Square section legs and 40 mm height-adjustable feet in 304 AISI stainless steel.
- Table top slots into legs without using screws to facilitate installation.

### Optional Accessories

- Set of 4 wheels (2 with brake) PNC 855150   
d. 100mm for tables and sinks  
(total height on wheels= 993 mm)
- Single drawer GN 1/1, 400mm PNC 855280
- Single drawer, 600mm PNC 855281
- Additional drawer, 600mm (to PNC 855295   
set up a chest of 2, 3, 4  
drawers)
- Additional drawer GN 1/1, PNC 855298   
400mm (to set up a chest of 2,  
3, 4 drawers)
- Lower shelf for 1300 mm tables PNC 855350   
and sinks
- 3-sided underframe for PNC 855357   
1300mm tables

**APPROVAL:** \_\_\_\_\_

**Front**

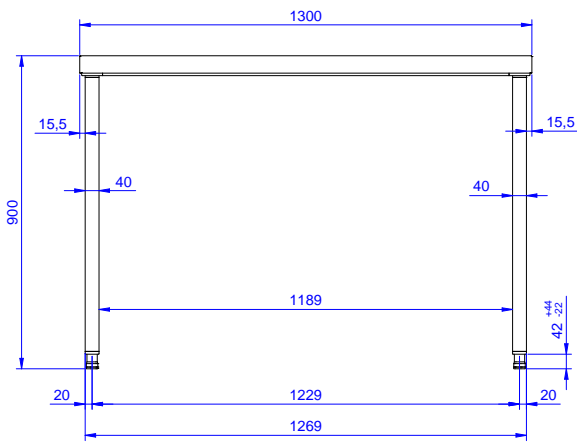

**Side**

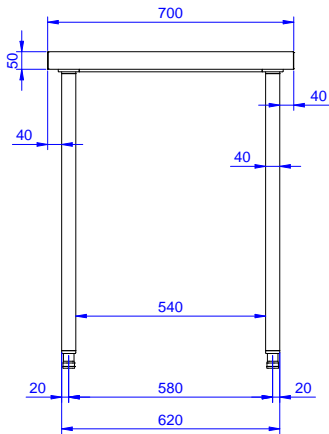

**Top**

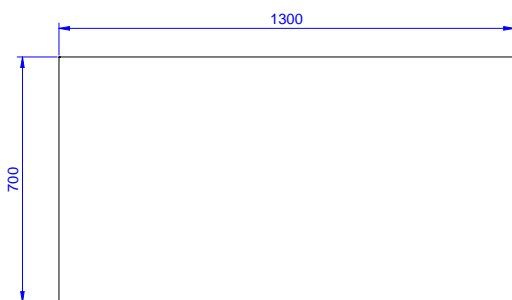

**Key Information:**

**External dimensions, Width:**

**133220 (TG1300N)** 1300 mm

**External dimensions, Depth:**

700 mm

**External dimensions, Height:**

900 mm

**Worktop thickness:**

50 mm

**Net weight:**

42 kg